



Pacific Northwest
NATIONAL LABORATORY

*Proudly Operated by **Battelle** Since 1965*

Georgia Residential Energy Code Field Study: Baseline Report

July 2017

R Bartlett
M Halverson
V Mendon

J Hathaway
Y Xie
M Zhao



Prepared for the U.S. Department of Energy
under Contract DE-AC05-76RL01830

DISCLAIMER

This report was prepared as an account of work sponsored by an agency of the United States Government. Neither the United States Government nor any agency thereof, nor Battelle Memorial Institute, nor any of their employees, makes **any warranty, express or implied, or assumes any legal liability or responsibility for the accuracy, completeness, or usefulness of any information, apparatus, product, or process disclosed, or represents that its use would not infringe privately owned rights.** Reference herein to any specific commercial product, process, or service by trade name, trademark, manufacturer, or otherwise does not necessarily constitute or imply its endorsement, recommendation, or favoring by the United States Government or any agency thereof, or Battelle Memorial Institute. The views and opinions of authors expressed herein do not necessarily state or reflect those of the United States Government or any agency thereof.

PACIFIC NORTHWEST NATIONAL LABORATORY
operated by
BATTELLE
for the
UNITED STATES DEPARTMENT OF ENERGY
under Contract DE-AC05-76RL01830

Printed in the United States of America

Available to DOE and DOE contractors from the
Office of Scientific and Technical Information,
P.O. Box 62, Oak Ridge, TN 37831-0062;
ph: (865) 576-8401
fax: (865) 576-5728
email: reports@adonis.osti.gov

Available to the public from the National Technical Information Service
5301 Shawnee Rd., Alexandria, VA 22312
ph: (800) 553-NTIS (6847)
email: orders@ntis.gov <<http://www.ntis.gov/about/form.aspx>>
Online ordering: <http://www.ntis.gov>



This document was printed on recycled paper.

(8/2010)

Georgia Residential Energy Code Field Study: Baseline Report

R Bartlett
M Halverson
V Mendon

J Hathaway
Y Xie
M Zhao

July 2017

Prepared for
the U.S. Department of Energy
under Contract DE-AC05-76RL01830

Pacific Northwest National Laboratory
Richland, Washington 99352

Executive Summary

A research project in the State of Georgia identified opportunities to reduce homeowner utility bills in residential single-family new construction by increasing compliance with the state energy code. The study was initiated in April 2015 and continued through November 2015. During this period, research teams visited 216 homes during various stages of construction, resulting in a substantial data set based on observations made directly in the field. Analysis of the data has led to a better understanding of the energy features present in homes, and indicates over \$3 million in potential annual savings to Georgia homeowners that could result from increased code compliance. Public and private entities within the state can use this information to justify and catalyze future investments in energy code training and related energy efficiency programs.

Methodology

The project team was led by the Southeast Energy Efficiency Alliance (SEEA). The team applied a methodology prescribed by the U.S. Department of Energy (DOE), which was based on collecting information for the energy code-required building components with the largest direct impact on energy consumption. These *key items* are a focal point of the study, and in turn drive the analysis and savings estimates. The project team implemented a customized sampling plan representative of new construction within the state, which was originally developed by Pacific Northwest National Laboratory (PNNL), and then vetted through public meetings with key stakeholders in the state.

Following data collection, PNNL conducted three stages of analysis on the resulting data set (Figure ES.1). The first stage identified compliance trends within the state based on what was observed in the field for each key item. The second modeled energy consumption (of the homes observed in the field) relative to what would be expected if sampled homes just met minimum code requirements. The third stage then calculated the potential energy savings, consumer cost savings, and avoided carbon emissions associated with increased code compliance. Together, these findings provide valuable insight on challenges facing energy code implementation and enforcement, and are intended to inform future energy code education, training and outreach activities.

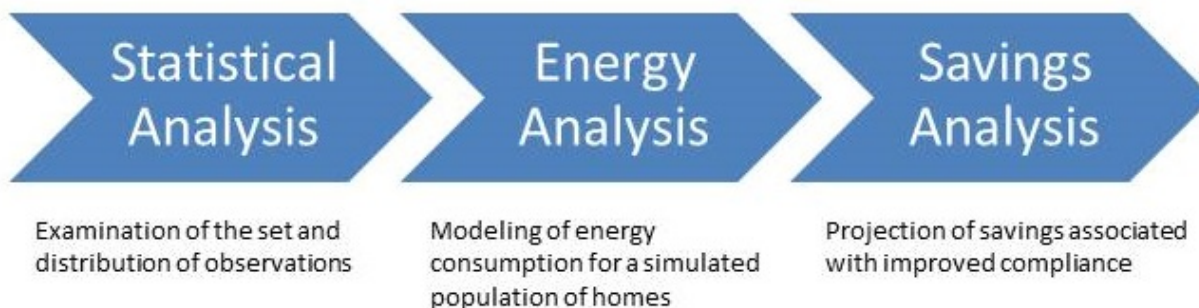

Figure ES.1. Stages of Analysis Applied in the Study

Results

The key items with the greatest potential for savings in Georgia are presented in Table ES.1. The estimates presented in the table represent the savings associated with each measure, and are extrapolated based on projected new construction. These items should be considered a focal point for compliance-improvement programs within the state, including energy code educational, training and outreach initiatives.

Table ES.1. Estimated Annual Statewide Savings Potential in Georgia (GA Energy Code)

Measure	Total Energy Savings (MMBtu)	Total Energy Cost Savings (\$)	Total State Emissions Reduction (MT CO ₂ e)
Exterior Wall Insulation	47,069	1,151,262	5,023
Lighting	15,774	799,065	3,837
Duct Leakage	25,387	685,683	3,005
Ceiling Insulation	14,397	371,110	1,635
TOTAL	102,627 MMBtu	\$3,007,120	13,500 MT CO₂e

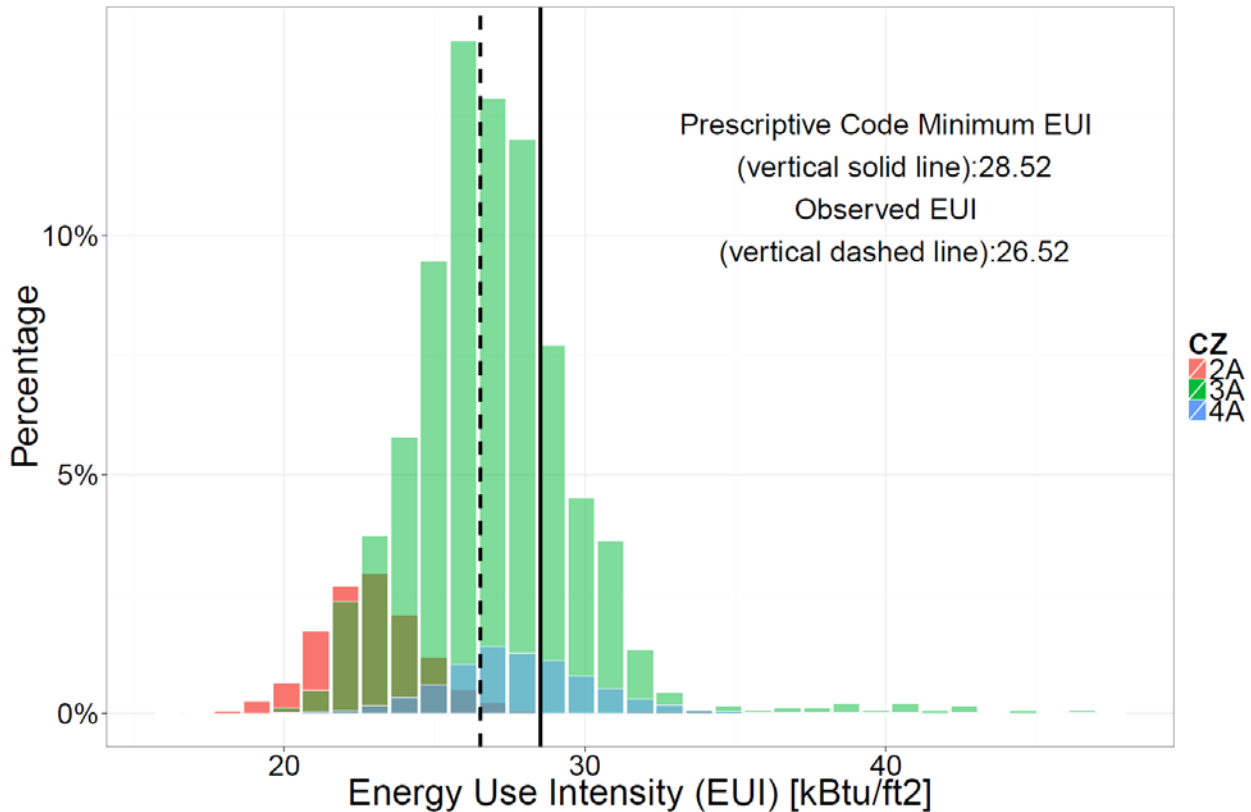

Figure ES.2. Modeled Distribution of Regulated EUI (kBtu/ft²/year) in Georgia (GA Energy Code)

In terms of overall energy consumption, the analysis shows that homes within the state use *less* energy than would be expected relative to homes built to the current minimum state code requirements (Figure ES.2). Analysis of the collected field data indicates average regulated energy use intensity (EUI) of 26.52 kBtu/ft²-yr statewide compared to 28.52 kBtu/ft²-yr for homes exactly meeting minimum prescriptive energy code requirements. This suggests that on average the typical home in the state is about 6% better than code.

Acknowledgments

The following members comprised the Georgia project team:

- Lauren Westmoreland, *Southeast Energy Efficiency Alliance (SEEA)*
- Amy Dzura, *SEEA*
- Bourke Reeve, *Southface*
- Chris North, *Southface*
- Mike Barcik, *Southface*

Southeast Energy Efficiency Alliance (SEEA)

SEEA is a nonprofit founded in 2007 and is one of six regional energy efficiency organizations dedicated to leveraging energy efficiency for the benefit of all citizens. SEEA supports smarter energy policies, stronger local energy codes, resources to upgrade the existing building stock, and opportunities to provide equal access to affordable energy for all communities. SEEA works collaboratively with many different stakeholder groups to service utilities, businesses and communities in 11 southeastern states, including Alabama, Arkansas, Florida, Georgia, Kentucky, Louisiana, Mississippi, North Carolina, South Carolina, Tennessee and Virginia. More information is available at <http://seealliance.org/>.

Southface

Since 1978, Southface Energy Institute has provided technical assistance to homeowners, builders, remodelers, architects, developers, utilities and others in the building industry. Southface has expertise in building science, energy efficiency and green design for new and existing buildings including single-family homes, multifamily buildings and commercial structures. Southface is a 501(c)(3) nonprofit organization headquartered in Atlanta, Georgia, with affiliated support throughout the southeast region. Southface develops and manages local, regional and national programs to promote sustainable homes, workplaces and communities. See more at <http://www.southface.org/>.

Acronyms and Abbreviations

AC	air conditioning
ACH	air changes per hour
AFUE	annual fuel utilization efficiency
AHU	air handling unit
AIA	American Institute of Architects
Btu	British thermal unit
cfm	cubic feet per minute
CZ	climate zone
DCA	Georgia Department of Community Affairs
DET	duct and envelope tightness
DOE	U.S. Department of Energy
EERE	Office of Energy Efficiency and Renewable Energy
EUI	energy use intensity
FOA	funding opportunity announcement
GA	Georgia
GEFA	Georgia Environmental Finance Authority
HSPF	heating season performance factor
ICC	International Code Council
IECC	International Energy Conservation Code
kBtu	thousand British thermal units
MMBtu	million British thermal units
NA	not applicable
PNNL	Pacific Northwest National Laboratory
RFI	request for information
SEEA	Southeast Energy Efficiency Alliance
SHGC	solar heat gain coefficient

Contents

Executive Summary	iii
Acknowledgments.....	v
Acronyms and Abbreviations	vii
1.0 Introduction	1.1
1.1 Background	1.1
1.2 Project Team	1.2
1.3 Stakeholder Interests	1.2
2.0 Methodology.....	2.1
2.1 Overview	2.1
2.2 State Study	2.2
2.2.1 Sampling.....	2.2
2.2.2 Data Collection.....	2.2
2.3 Data Analysis	2.3
2.3.1 Statistical Analysis	2.4
2.3.2 Energy Analysis	2.5
2.3.3 Savings Analysis	2.5
2.4 Limitations	2.6
2.4.1 Applicability of Results.....	2.6
2.4.2 Determination of Compliance	2.6
2.4.3 Sampling Substitutions.....	2.6
2.4.4 Site Access	2.6
2.4.5 Analysis Methods.....	2.7
2.4.6 Presence of Tradeoffs.....	2.7
3.0 State Results	3.1
3.1 Field Observations.....	3.1
3.1.1 Key Items	3.1
3.1.2 Additional Data Items	3.11
3.2 Energy Intensity	3.12
3.3 Savings Potential.....	3.14
4.0 Conclusions	4.1
5.0 References	5.1
Appendix A – Stakeholder Participation	A.1
Appendix B – State Sampling Plan.....	B.1
Appendix C – Additional Data	C.1

Figures

2.1	Sample Graph	2.4
3.1	Envelope Tightness.....	3.2
3.2	Window SHGC.....	3.3
3.3	Window U-Factor	3.4
3.4	Wall Assembly R-Value in CZs 2A, 3A, and 4A	3.5
3.5	Wall Assembly Performance, including Insulation Installation Quality in CZ 2A	3.6
3.6	Wall Assembly Performance, including Insulation Installation Quality in CZ 3A	3.6
3.7	Wall Assembly Performance, including Insulation Installation Quality in CZ 4A	3.7
3.8	Ceiling R-Value	3.8
3.9	High-efficacy Lighting Percentage	3.9
3.10	Duct Tightness	3.10
3.11	Statewide EUI Analysis for Georgia.....	3.13
3.12	Statewide EUI Analysis for Georgia.....	3.14

Tables

Table 3.1. Envelope Tightness (ACH50).....	3.2
Table 3.2. Window SHGC	3.3
Table 3.3. Window U-Factor	3.4
Table 3.4. Frame Wall Assembly.....	3.7
Table 3.5. Ceiling R-Value	3.8
Table 3.6. High-efficacy Lighting Percentage	3.9
Table 3.7. Duct Tightness	3.10
Table 3.8. Insulation Installation Quality.....	3.11
Table 3.9. Statewide Annual Measure-Level Savings for Georgia (GA Energy Code)	3.15
Table 3.10. Five-years, Ten-years, and Thirty-years Cumulative Annual Statewide Savings for Georgia (GA Energy Code)	3.16
Table 4.1. Annual Statewide Savings Potential in Georgia	4.1

1.0 Introduction

A research project in the State of Georgia investigated the energy code-related aspects of unoccupied, newly constructed, single family homes across the state. The study followed a DOE-prescribed methodology, which allowed the project team to build an empirical data set based on observations made directly in the field. The data was then analyzed to identify compliance trends, their impact on statewide energy consumption, and calculate savings that could be achieved through increased code compliance. Study findings can help to justify additional support for energy code education, training & outreach activities, as well as catalyze future investments in compliance-improvement programs.

The Georgia field study was initiated in April 2015 and continued through November 2015. During this period, research teams visited 216 homes across the state during various stages of construction. At the time of the study, the state had the 2011 Georgia Energy Code¹, an amended version of the 2009 International Energy Conservation Code (IECC). The study methodology, data analysis and resulting findings are presented throughout this report.

1.1 Background

The data collected and analyzed for this report was in response to the U.S. Department of Energy (DOE) Funding Opportunity Announcement (FOA), “Strategies to Increase Residential Energy Code Compliance Rates and Measure Results”.² The goal of the FOA is to determine whether an investment in education, training, and outreach programs can produce a significant, measurable change in single-family residential building code energy use, and therefore energy savings, within 2-3 years. Participating states are:

- Conducting a baseline field study to determine installed energy values of code-required items, identify issues, and calculate savings opportunities;
- Implementing education, training, and outreach activities designed to increase code compliance; and
- Conducting a second field study to measure the post-training values using the same methodology as the baseline study.

Energy codes for residential buildings have advanced significantly in recent years, with today’s model codes approximately 30% more efficient than codes adopted by the majority of U.S. states.^{3,4} Hence, the importance of ensuring code-intended energy savings, so that consumers reap the benefits of improved codes—something which will happen only through high levels of compliance. More information on the FOA and overall DOE interest in compliance is available on the DOE Building Energy Codes Program website.⁵

¹ Georgia’s amendments are available at http://www.dca.state.ga.us/development/constructioncodes/programs/documents/IECC2011Amendments-effective_001.pdf

² Available at <https://www.energycodes.gov/compliance/residential-energy-code-field-study>

³ *National Energy and Cost Savings for New Single- and Multifamily Homes: A Comparison of the 2006, 2009, and 2012 Editions of the IECC*, available at <http://www.energycodes.gov/development>

⁴ Available at <http://www.energycodes.gov/adoption/states>

⁵ Available at <https://www.energycodes.gov/compliance>

1.2 Project Team

The Georgia project was led by the Southeast Energy Efficiency Alliance (SEEA), with field study data collected by Southface. The Pacific Northwest National Laboratory (PNNL) defined the methodology, conducted data analysis, and provided technical assistance to the project team. Funding and overall program direction was provided by the DOE Building Energy Codes Program as part of a broader initiative being conducted across several U.S. states. More information on the organizations comprising the project team is included in the Acknowledgements section of this report.

1.3 Stakeholder Interests

The project started with the formation of a stakeholder group comprised of interested and affected parties within the state. Following an initial kickoff meeting, the project team maintained active communication with the stakeholders throughout the course of the project. Stakeholders were sought from the following groups:

- Building officials
- Homebuilders
- Subcontractors
- Material supply distributors
- Government agencies
- Energy efficiency advocates
- Utilities
- Other important entities identified by the project team

A description of the stakeholders who participated in the project to date is included in Appendix A.

Members of these and other groups are critical to the success of the project, as they hold important information (e.g., building officials have the lists of homes under construction and are therefore key to the sampling process), control access to homes needed for site visits, are targets for training, or, as is often the case with government agencies, have oversight responsibilities for code adoption and implementation. Utilities were also identified as a crucial stakeholder, and often have direction from state regulatory bodies (e.g., the public utility commission) to achieve energy savings. Many utilities have expressed an increasing interest in energy code investments, and are looking at energy code compliance as a means to provide assistance and generate additional savings. The field study is aimed specifically at providing a strong, empirically-based case for such utility investment.

In Georgia, SEEA acquired utility funding from Georgia Power to collect additional data for analysis within the utility's service territory. As Georgia Power does not serve the entire state, the DOE statewide study would not have been able to distinguish characteristics specific to Georgia Power's service territory. For example, Georgia Power serves mostly large metropolitan regions, such as Atlanta and Savannah, where there has been much more access to education and outreach for the construction industry on energy code compliance. The immediate goal was to compare the statewide results to Georgia Power's service territory to better understand the relationship between the results. The results from the Georgia Power data collection are not included in this report.

2.0 Methodology

2.1 Overview

The Georgia field study was based on a methodology developed by DOE to identify savings opportunities associated with increased energy code compliance. This methodology involves gathering field data on energy code measures, as installed and observed in actual homes. In the subsequent analysis, trends and issues are identified, which can inform energy code training and other compliance-improvement programs.

Highlights of the methodology:

- Focuses on **individual code requirements** within **new single-family homes**
- Based on a **single site visit** to reduce burden and minimize bias
- Prioritizes **key items** with the greatest impact on energy consumption
- Designed to produce statistically significant results
- **Data confidentiality** built into the experiment—no occupied homes were visited, and no personal data shared
- Results based on an **energy metric** and reported at the **state level**

PNNL identified the code-requirements (and associated energy efficiency measures) with the greatest direct impact on residential energy consumption.¹ These *key items* drive sampling, data analysis, and eventual savings projections:

1. Envelope tightness (ACH at 50 Pascals)
2. Windows (U-factor & SHGC)
3. Wall insulation (assembly U-factor)
4. Ceiling insulation (R-value)
5. Lighting (% high-efficacy)
6. Foundation insulation (R-value)²
7. Duct tightness (expressed in cfm per 100 ft² of conditioned floor area at 25 Pascals)

PNNL evaluated the variability associated with each key item, and concluded that a minimum of 63 observations would be needed for each one to produce statistically significant results at the state level. Both the key items themselves and the required number of observations were prescribed in the DOE methodology.

The following sections describe how the methodology was implemented as part of the Georgia study, including sampling, data collection, and resulting data analysis. More information on the DOE data

¹ Based on the *mandatory* and *prescriptive* requirements of the International Energy Conservation Code (IECC)

² Floor insulation, basement wall insulation, crawlspace wall insulation, and slab insulation are combined into a single category of foundation insulation.

collection and analysis methodologies is published separately from this report (DOE 2016) and is available on the DOE Building Energy Codes Program website.³

2.2 State Study

The prescribed methodology was customized for the state of Georgia to reflect circumstances unique to the state, such as state-level code requirements and regional construction practices. Customization also ensured that the results of the study would have credibility with stakeholders.

2.2.1 Sampling

PNNL developed a statewide sampling plan statistically representative of recent construction activity within the state. The samples were apportioned to jurisdictions across the state in proportion to their average level of construction compared to the overall construction activity statewide. This approach, known as a proportional random sample, was based on the average of the three most recent years of Census Bureau permit data⁴. The plan specified the number of key item observations required in each selected jurisdiction (totaling 63 of each key item across the entire state).

An initial sample plan was first developed by PNNL, and then vetted by stakeholders within the state. Special considerations were discussed by stakeholders at a project kickoff meeting, such as state-specific construction practices or systematic differences across county or climate zone boundaries. These considerations were taken into account and incorporated into the final statewide sample plan shown in Appendix B.

2.2.2 Data Collection

Following confirmation of the sample plan, the project team began contacting local building departments to identify homes currently in the permitting process. Code officials responded by providing a list of homes at various stages of construction within their jurisdiction. These lists were then sorted using a random number generator and utilized by the team's field personnel to contact builders to gain site access. As prescribed by the methodology, each home was visited only once to avoid any bias associated with multiple site visits. Only installed items directly observed by the field teams during site visits were recorded. If access was denied for a particular home on the list, field personnel moved onto the next home on the list.

2.2.2.1 Data Collection Form

The field teams relied on a data collection form customized to the *mandatory* and *prescriptive* requirements of the state energy code during the time of the study (2011 Georgia Energy Code). The final data collection form is available in spreadsheet format on the DOE Building Energy Codes Program website.⁵ The form included *all* energy code requirements (i.e., not just the eight key items), as well as additional items required under the prescribed methodology. For example, the field teams were required

³ Available at <https://www.energycodes.gov/compliance/residential-energy-code-field-study>

⁴ Available at <http://censtats.census.gov/> (select the "Building Permits" data)

⁵ Available at <https://www.energycodes.gov/compliance/residential-energy-code-field-study> and based on the forms typically used by the REScheck compliance software.

to conduct a blower door test and duct leakage test on every home where such tests could be conducted, using RESNET⁶ protocols.

The information beyond the key items was used during various phases of the analysis, or to supplement the overall study findings. For example, insulation installation quality impacts the energy efficiency of insulation and was therefore used to modify that key item during the energy modeling and savings calculation. Equipment, including fuel type and efficiency rating, and basic home characteristics (e.g., foundation type) helped validate the prototype models applied during energy simulation. Other questions, such as whether the home participated in an above-code program, can assist in understanding whether other influencing factors are at play beyond the code requirements.

The data collected were the energy values observed, rather than the compliance status. For insulation, for example, the R-value was collected, for windows the U-factor. The alternative, such as was used in DOE's older work, simply stated whether an item did or did not comply. The current approach provides an improved understanding of how compliance equates to energy consumption, and gives more flexibility during analysis since the field data can be compared to any energy code.

2.2.2.2 Data Management and Availability

Once the data collection effort was complete, the project team conducted a thorough quality assurance review. This included an independent check of raw data compared to the information provided to PNNL for analysis, and helped to ensure completeness, accuracy and consistency across the inputs. Prior to submitting the data to PNNL, the team also removed all personally identifiable information, such as project site locations and contact information. The final dataset is available in spreadsheet format on the DOE Building Energy Codes Program website.⁷

2.3 Data Analysis

All data analysis in the study was performed by PNNL, and was applied through three basic stages:

1. **Statistical Analysis:** Examination of the data set and distribution of observations for individual measures
2. **Energy Analysis:** Modeling of energy consumption for a simulated population of homes
3. **Savings Analysis:** Projection of savings associated with improved compliance

The first stage identified compliance trends within the state based on what was observed in the field for each key item. The second modeled energy consumption (of the homes observed in the field) relative to what would be expected if sampled homes just met minimum code requirements. The third stage then calculated the potential energy savings, consumer cost savings, and avoided carbon emissions associated with increased code compliance. Together, these findings provide valuable insight on challenges facing energy code implementation and enforcement, and are intended to inform future energy code education, training and outreach activities.

The following sections provide an overview of the analysis methods applied to the field study data, with the resulting state-level findings presented in Section 3.0, State Results.

⁶ See http://www.resnet.us/standards/RESNET_Mortgage_Industry_National_HERS_Standards.pdf

⁷ Available at <https://www.energycodes.gov/compliance/residential-energy-code-field-study>

2.3.1 Statistical Analysis

Standard statistical analysis was performed with distributions of each key item plotted by climate zone. This approach enables a better understanding of the range of data, and provides insight on what energy-efficiency measures are most commonly installed in the field. It also allows for a comparison of installed values to the applicable code requirement, and for identification of any problem areas where potential for improvement exists. The graph below represents a sample key item distribution, and is further explained in the following paragraph.

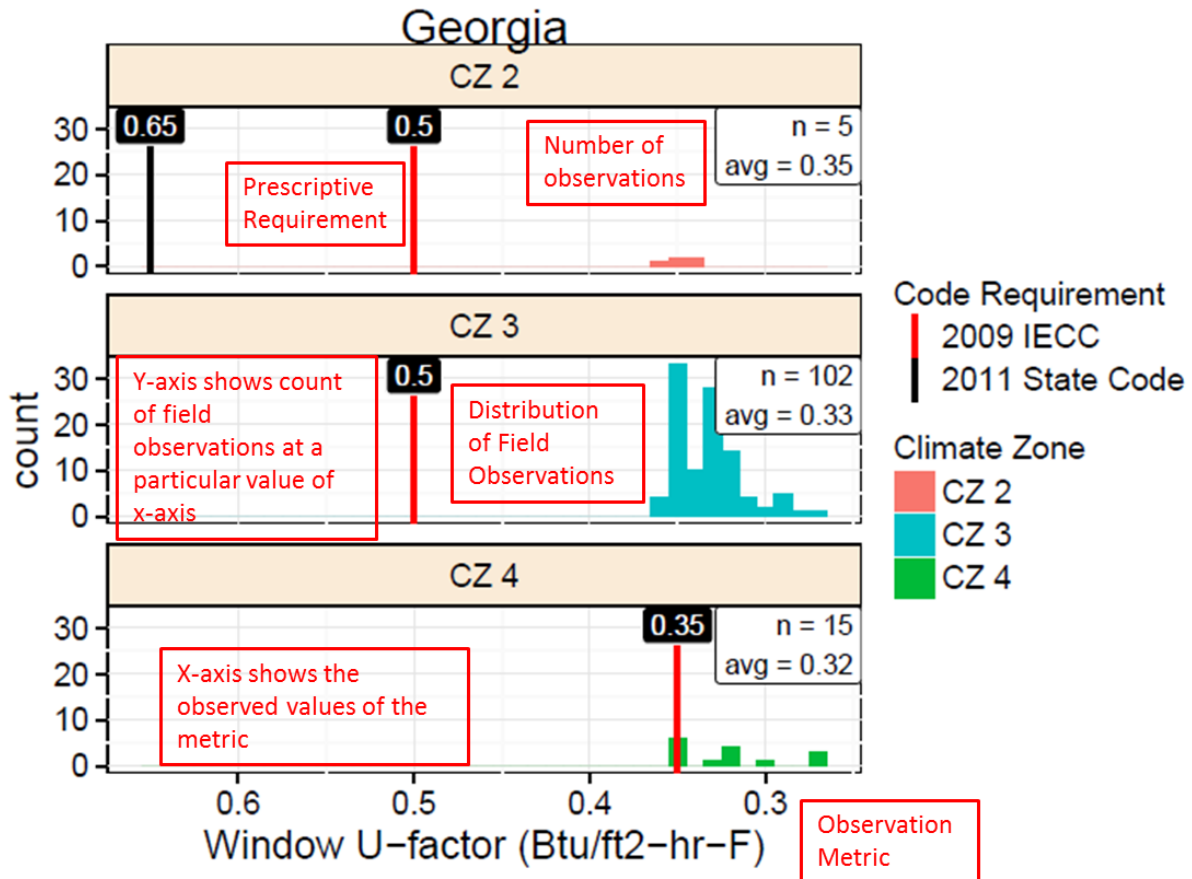

Figure 2.1. Sample Graph

Each graph is set up in a similar fashion, identifying the *state*, *climate zone*, and specific item being analyzed. The total *sample size* (n) is displayed in the top left or right corner of the graph, along with the distribution *average*. The *metric* associated with the item is measured along the horizontal axis (e.g., window U-factor is measured in Btu/ft²-hr-F), and a *count* of the number of observations is measured along the vertical axis. A vertical line is imposed on the graph representing the applicable code requirement. In this case, the observations are compared to two codes; the red line represents the requirement of the 2009 IECC, and the black line represents the requirement of Georgia’s amended 2009 IECC – values to the right-hand side of this line are *better than code*. Values to the left-hand side represent areas for improvement.

2.3.2 Energy Analysis

The next phase of the analysis leveraged the statistical analysis results to model average statewide energy consumption. A consequence of the field study methodology allowing only one site visit per home to minimize bias is that a full set of data cannot be gathered on any single home, as not all energy-efficiency measures are in place or visible at any given point during the home construction process. This lack of complete data for individual homes creates an analytical challenge, because energy modeling and simulation protocols require a complete set of inputs to generate reliable results. To address this challenge, a series of “pseudo homes” were created, comprised of over 1,500 models encompassing most of the possible combinations of key item values found in the observed field data. In aggregate, the models provide a statistical representation of the state’s population of newly constructed homes. This approach is known in statistics as a Monte Carlo analysis.

Energy simulation was then conducted using the EnergyPlus™ software.⁸ Each of the 1,500 models was run multiple times, to represent each combination of heating systems and foundation types commonly found in the state. This resulted in upwards of 30,000 simulation runs for each climate zone within the state. An EUI was calculated for each simulation run and these results were then weighted by the frequency with which the heating system/foundation type combinations were observed in the field data. Average EUI was calculated based on regulated end uses (heating, cooling, lighting and domestic hot water) for two sets of homes—one *as-built* set based on the data collected in the field, and a second *code-minimum* set (i.e., exactly meeting minimum code requirements). Comparing these values shows whether the population of newly constructed homes in the state is using more or less energy than would be expected based on minimum code requirements.

Further specifics of the energy analysis are available in a supplemental methodology report (DOE 2016).⁹

2.3.3 Savings Analysis

To begin the third phase, each of the key items was examined individually to determine which had a significant number of observed values that did not meet the associated code requirement¹⁰. For these items, additional models were created to assess the savings potential, comparing what was observed in the field to a scenario of full compliance (i.e., where all worse-than-code observations for a particular item exactly met the corresponding code requirement)¹¹. The worse-than-code observations for the key item under consideration are used to create a second set of models (*as built*) that can be compared to the baseline (*full compliance*) models. All other components were maintained at the corresponding prescriptive code value, allowing for the savings potential associated with a key item to be evaluated in isolation.

All variations of observed heating systems and foundation types were included, and annual electric, gas and total EUIs were extracted for each building. To calculate savings, the differences in energy use calculated for each case were weighted by the corresponding frequency of each observation to arrive at an average energy savings potential for each climate zone. Potential energy savings for each climate zone were further weighted using construction starts in that zone to obtain the average statewide energy

⁸ See <https://energyplus.net/>

⁹ Available at <https://www.energycodes.gov/compliance/residential-energy-code-field-study>

¹⁰ “Significant” was defined as 15% or more of the observed values not meeting the associated code requirement. Only the items above this threshold were analyzed.

¹¹ Better-than-code items were not included in this analysis because the intent was to identify the maximum savings potential for each measure. The preceding energy analysis included both better-than-code and worse-than-code results, allowing them to offset each other.

savings potential. State-specific construction volumes and fuel prices were used to calculate the maximum energy savings potential for the state in terms of *energy* (MMBtu), *energy cost* (\$), and avoided *carbon emissions* (MT CO_{2e}).

Note that this approach results in the maximum theoretical savings potential for each measure as it does not take “interaction effects” into account such as the increased amount of heating needed in the winter when energy efficient lights are installed. A building’s energy consumption is a dynamic and interactive process that includes all the building components present within a given home. In a typical real building, the savings potential might be higher or lower, however, additional investigation indicated that the relative impact of such interactions is very small, and could safely be ignored without changing the basic conclusions of the analysis.

2.4 Limitations

The following sections address limitations of the project, some of which are inherent to the methodology, itself, and other issues as identified in the field.

2.4.1 Applicability of Results

An inherent limitation of the study design is that the results are statistically significant only at the state level. Other results of interest, such as analysis based on climate zone level or reporting of non-key items, were also identified. While some of these items are visible in the publicly available data set, they should not be considered statistically representative.

2.4.2 Determination of Compliance

The field study protocol is based upon a single site visit, which makes it impossible to know whether a particular home complies with the energy code as not enough information can be gathered in a single visit to know whether all code requirements have been met. For example, homes observed during the earlier stages of construction often lack key features (e.g., walls with insulation), and in the later stages many of these items may be covered and therefore unobservable. To gather all the data required in the sampling plan, field teams therefore needed to visit homes in various stages of construction. The analytical implications of this are described above in Section 2.3.2.

2.4.3 Sampling Substitutions

As is often the case with field-based research, substitutions to the state sampling plan were sometimes needed to fulfill the complete data set. If the required number of observations in a jurisdiction could not be met because of a lack of access to homes or an insufficient number of homes (as can be the case in rural areas), substitute jurisdictions were selected by the project team. In all cases, the alternative selection was comparable to the original in terms of characteristics such as the level of construction activity and general demographics. More information on the sampling plan and any state-specific substitutions are discussed in Appendix B.

2.4.4 Site Access

Site access was purely voluntary and data was collected only in homes where access was granted, which can be characterized as a self-selection bias. While every effort was made to limit this bias (i.e., sampling

randomization, outreach to builders, reducing the burden of site visits, etc.), it is inherent due to the voluntary nature of the study. The impacts of this bias on the overall results are not known.

2.4.5 Analysis Methods

All energy analysis was conducted using prototype models; no individually visited homes were modeled, as the self-imposed, one-visit-per-home limitation meant that not all necessary modeling inputs could be collected from a single home. Thus, the impact of certain field-observable factors such as size, height, orientation, window area, floor-to-ceiling height, equipment sizing, and equipment efficiency were not included in the analysis. In addition, duct leakage was modeled separately from the other key items due to limitations in the EnergyPlus™ software used for analysis. It should also be noted that the resulting energy consumption and savings projections are based on modeled data, and not on utility bills or actual home energy usage.

2.4.6 Presence of Tradeoffs

Field teams were able to gather only a minimal amount of data regarding which code compliance paths were being pursued for homes included in the study; all analyses therefore assumed that the prescriptive path was used. The project team agreed that this was a reasonable approach. The overall data set was reviewed in an attempt to determine if common tradeoffs were present, but the ability to do this was severely limited by the single site-visit principle which did not yield complete data sets for a given home. To the extent it could be determined, it did not appear that there was a systematic presence of tradeoffs.

3.0 State Results

3.1 Field Observations

The key items form the basis of the study, and are therefore the focus of this section. Georgia comprises multiple climate zones; zone 2 (CZ2), zone 3 (CZ3), and zone 4 (CZ4). All climate zones are represented in the sampling, data collection, and resulting analysis and statewide savings calculations. A discussion of other findings is also covered in this section, including a description of how certain observations, such as insulation installation quality, are used to modify key item results. (See Section 2.3.1 for a sample graph and explanation of how they should be interpreted.) For Georgia, the observations are compared to two codes; the red line represents the requirement of the 2009 IECC, and the black line represents the requirement of Georgia's current state code. Values to the right-hand side of this line are *better than code*.

3.1.1 Key Items

The field study and underlying methodology are driven by *key items* that have a significant direct impact on residential energy efficiency. The graphs presented in this section represent the key item results for the state based on the measures observed in the field. Note that these key items are also the basis of the results presented in the subsequent *energy* and *savings* phases of analysis.

The following key items were found applicable within the state:

1. Envelope tightness (ACH at 50 Pascals)
2. Windows (U-factor and SHGC)
3. Wall insulation (assembly U-factor)
4. Ceiling insulation (R-value)
5. Lighting (% high-efficacy)
6. Duct tightness (expressed in cfm per 100 ft² of conditioned floor area at 25 Pascals)

A variety of foundation types were also observed across the state. While foundation insulation was specified as a key item, and the project teams were responsible for collecting the required number of associated data points, the variety resulted in few observations for any one foundation type. For this reason, foundation insulation is not included in this section.

3.1.1.1 Envelope Tightness

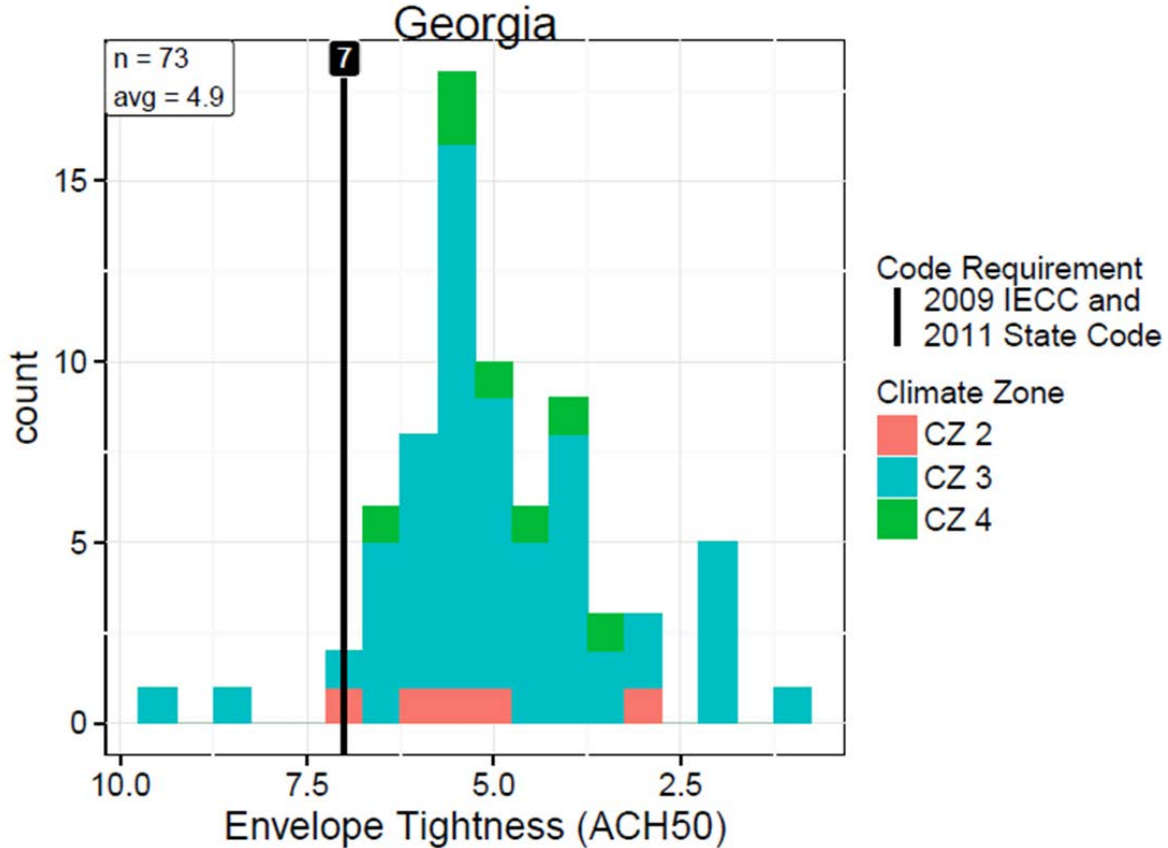

Figure 3.1. Envelope Tightness (ACH50)

Table 3.1. Envelope Tightness (ACH50)

Climate Zone	CZ2	CZ3	CZ4	Statewide
<i>Number</i>	5	61	7	73
<i>Range</i>	6.9 to 2.8	9.28 to 1.1	6.53 to 3.30	9.28 to 1.1
<i>Average</i>	5.2	4.9	4.9	4.9
<i>Requirement</i>	7	7	7	7
<i>Compliance Rate</i>	5 of 5 (100%)	58 of 61 (95%)	7 of 7 (100%)	70 of 73 (96%)

• **Interpretations:**

- Statewide, 96% (70 of 73) of the observations met or exceeded the code requirement. Envelope air leakage requirements appear to be met successfully within the state.

The project team noted that Georgia adopted a strengthening amendment to the 2009 IECC, which changes the envelope leakage test from voluntary to mandatory. Since January 1, 2012, all new single-family houses are required to show compliance with the 7 ACH50 requirement through testing. The team also noted that envelope tightness has been an area of training focus, including the development of a state-specific program called the Duct and Envelope Tightness (DET) Verifier Program which trained additional individuals to conduct testing.

3.1.1.2 Window SHGC

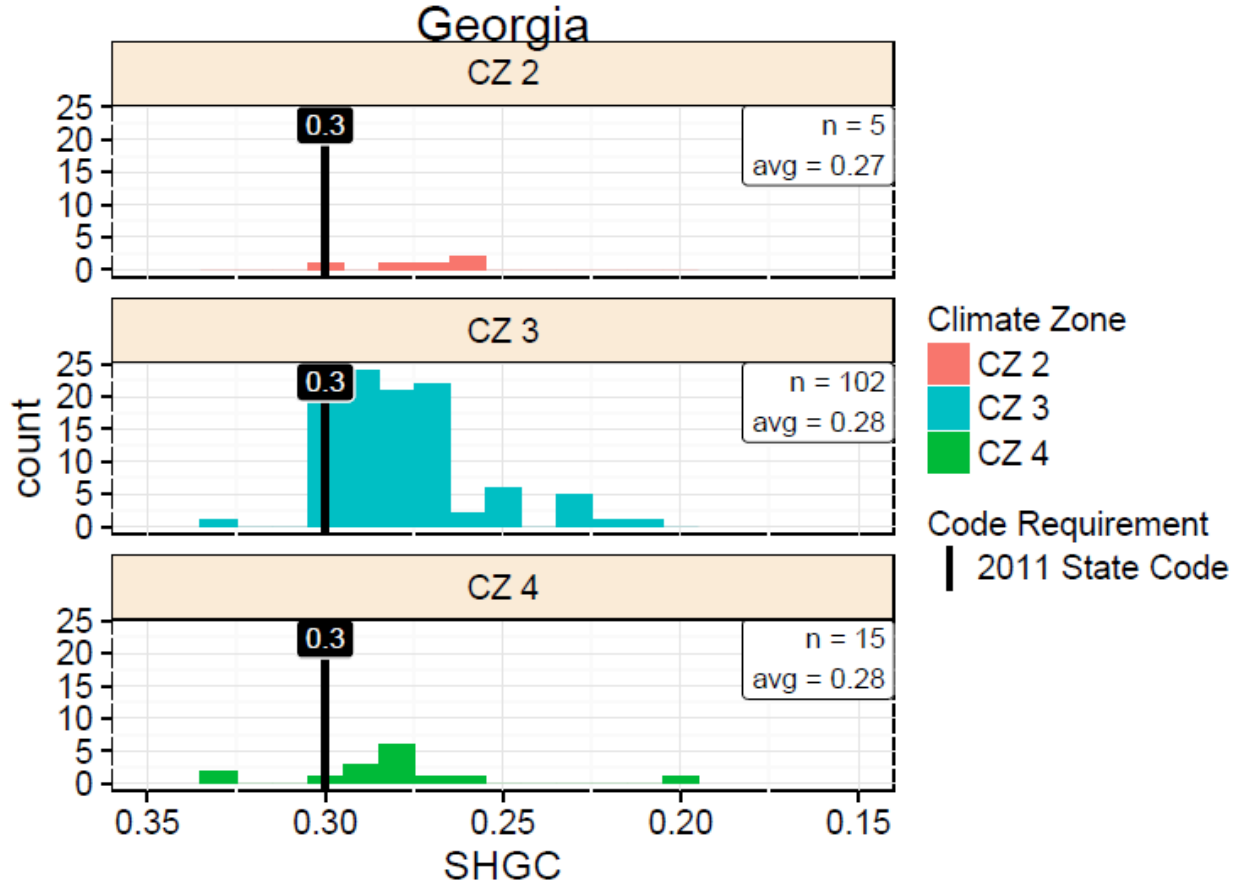

Figure 3.2. Window SHGC

Table 3.2. Window SHGC

Climate Zone	CZ2	CZ3	CZ4	Statewide
Number	5	102	15	122
Range	0.30 to 0.26	0.33 to 0.21	0.33 to 0.20	0.33 to 0.20
Average	0.27	0.28	0.28	0.28
Requirement	0.3	0.3	0.3	0.3
Compliance Rate	5 of 5 (100%)	101 of 102 (99%)	13 of 15 (87%)	119 of 122 (98%)

• Interpretations:

- SHGC values consistently exceeded the prescriptive requirement for all climate zones.
- The vast majority of the observations were in the 0.25 to 0.30 SHGC range.

3.1.1.3 Window U-Factor

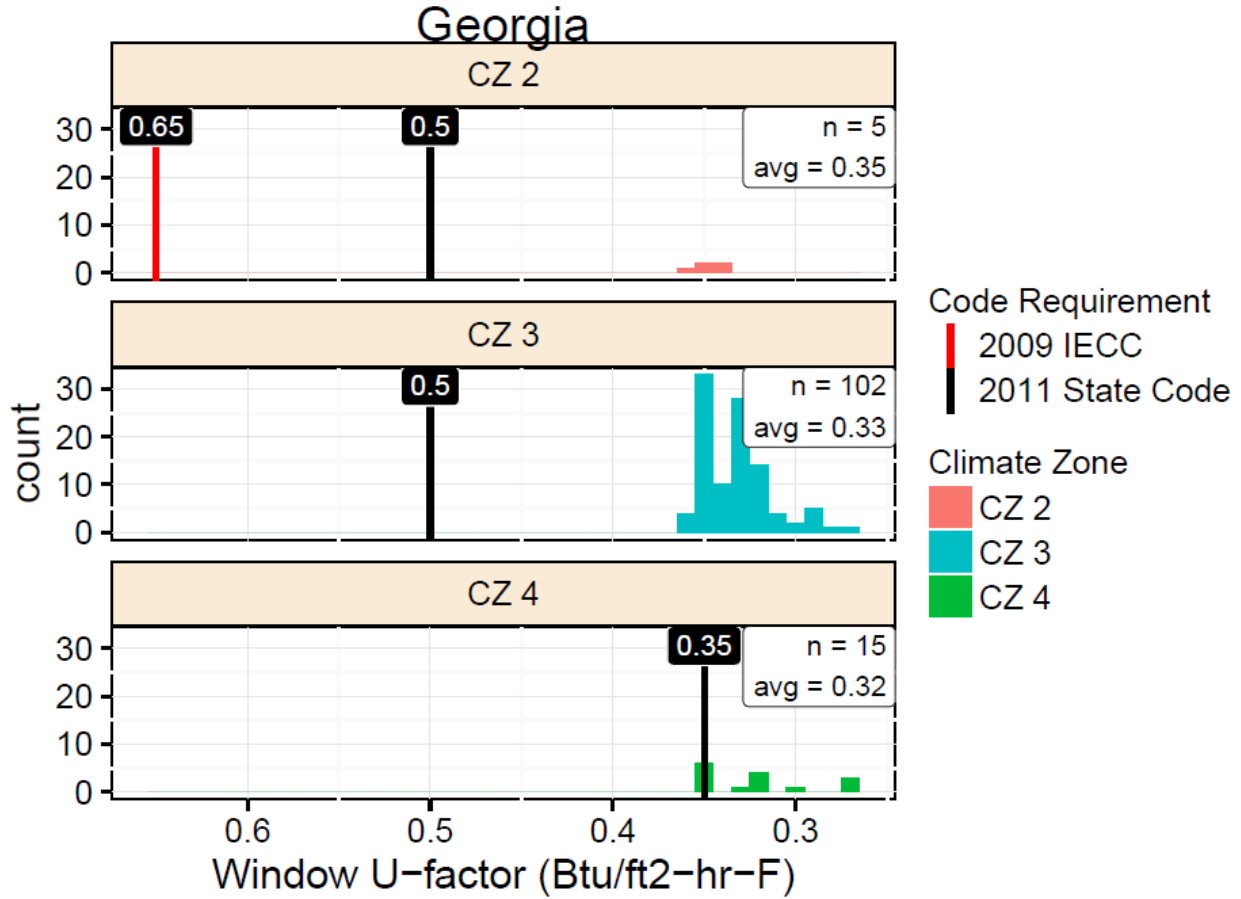

Figure 3.3. Window U-Factor

Table 3.3. Window U-Factor

Climate Zone	CZ2	CZ3	CZ4	Statewide
Number	5	102	15	122
Range	0.36 to 0.34	0.36 to 0.27	0.35 to 0.27	0.36 to 0.27
Average	0.35	0.33	0.32	4.3
Requirement	0.5 (2011 State Code), 0.65 (2009 IECC)	0.5 (both codes)	0.35 (both codes)	Varies as shown
Compliance Rate	5 of 5 (100%) for both codes	102 of 102 (100%) (both codes)	15 of 15 (100%) (both codes)	122 of 122 (100%)

• **Interpretations:**

- There is 100% compliance for fenestration products in the state against both codes.
- Window U-factor requirements appear to have been implemented with a high rate of success across the state.

3.1.1.4 Wall Insulation

Wall insulation data is presented in terms of both frame cavity insulation and overall assembly performance in order to capture the conditions seen in the field. The cavity insulation data is based on the observed value (R-value), as printed on the manufacturer label and installed in the home. While cavity insulation is important, it is not fully representative of wall assembly performance, since this data point alone does not account for other factors that can have a significant effect on the wall system (e.g., combinations of cavity and continuous insulation). Therefore, wall insulation is also presented from a second perspective—overall assembly performance (U-factor).

Figure 3.4 represents the distribution of observed values for wall cavity insulation across all climate zones.

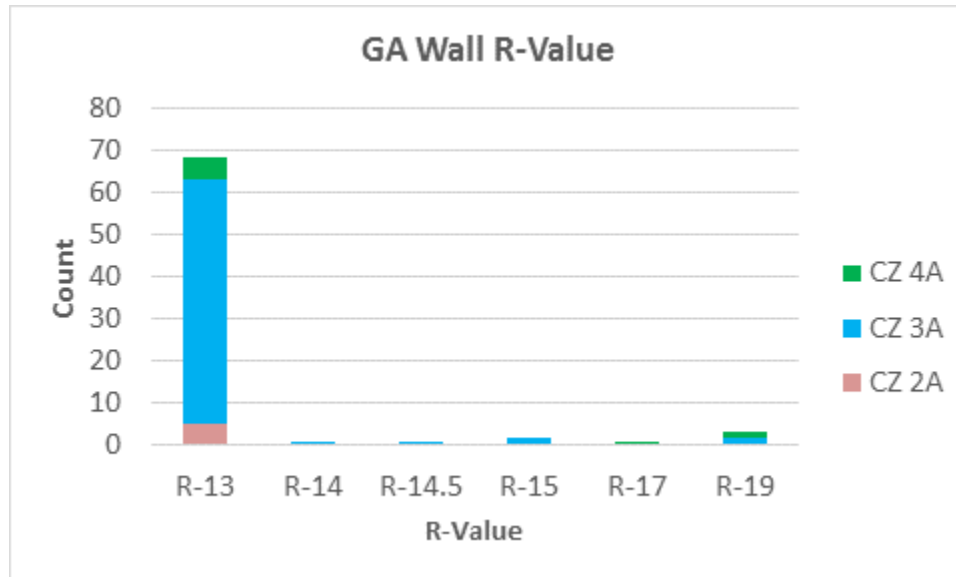

Figure 3.4. Wall Assembly R-Value in CZs 2A, 3A, and 4A

Figure 3.5, Figure 3.6, and Figure 3.7 represent overall wall assembly performance (U-factor). The U-factor perspective takes into account combined insulation values (any cavity and/or continuous insulation that was installed in the home), as well as framing, and insulation installation quality, as observed in the field. This approach illustrates the additional savings possible through proper installation. In the graphs, observations are binned for clearer presentation based on the most commonly observed combinations.

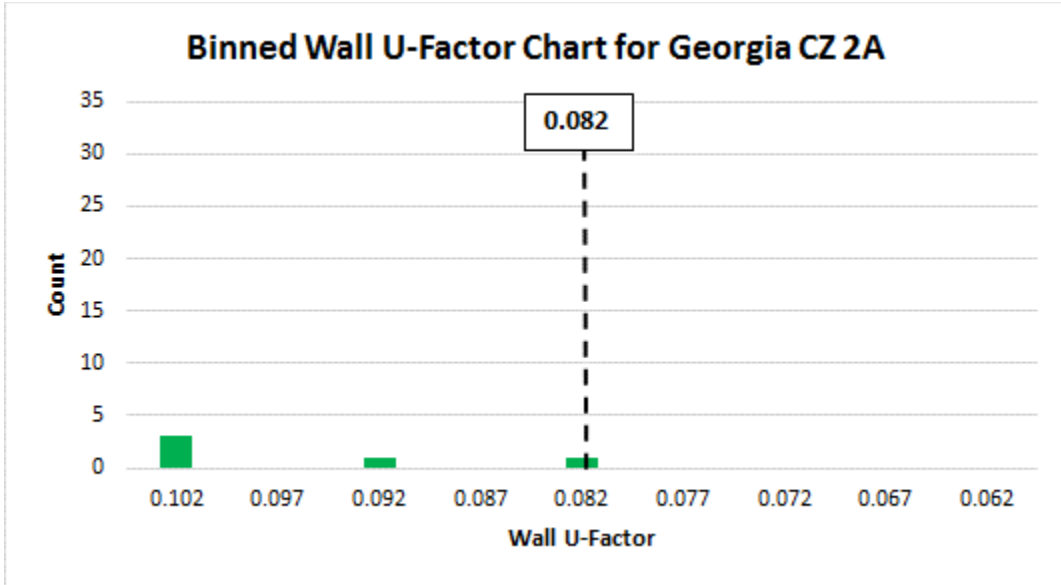

Figure 3.5. Wall Assembly Performance, including Insulation Installation Quality in CZ 2A

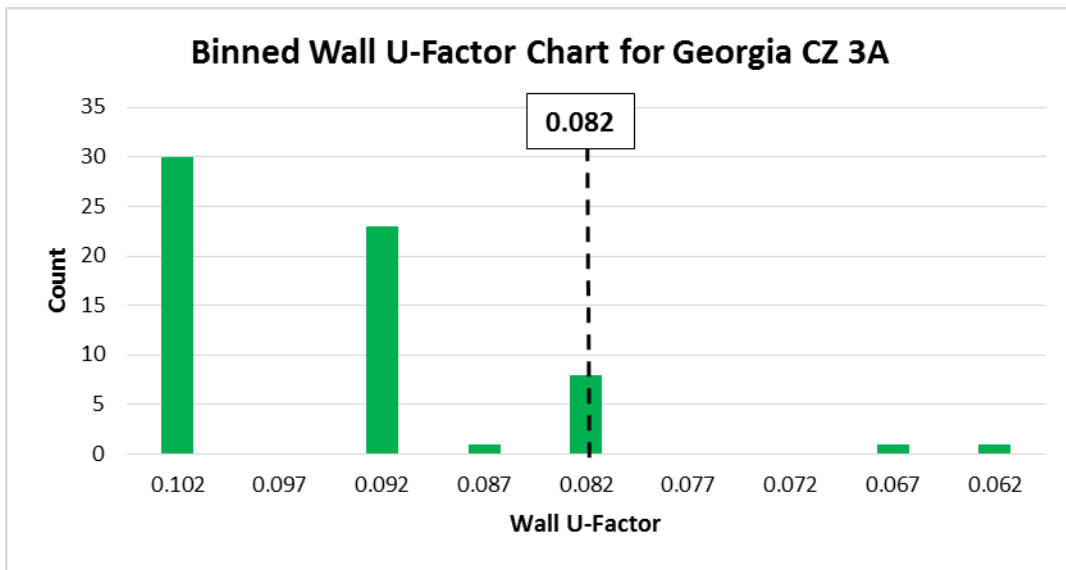

Figure 3.6. Wall Assembly Performance, including Insulation Installation Quality in CZ 3A

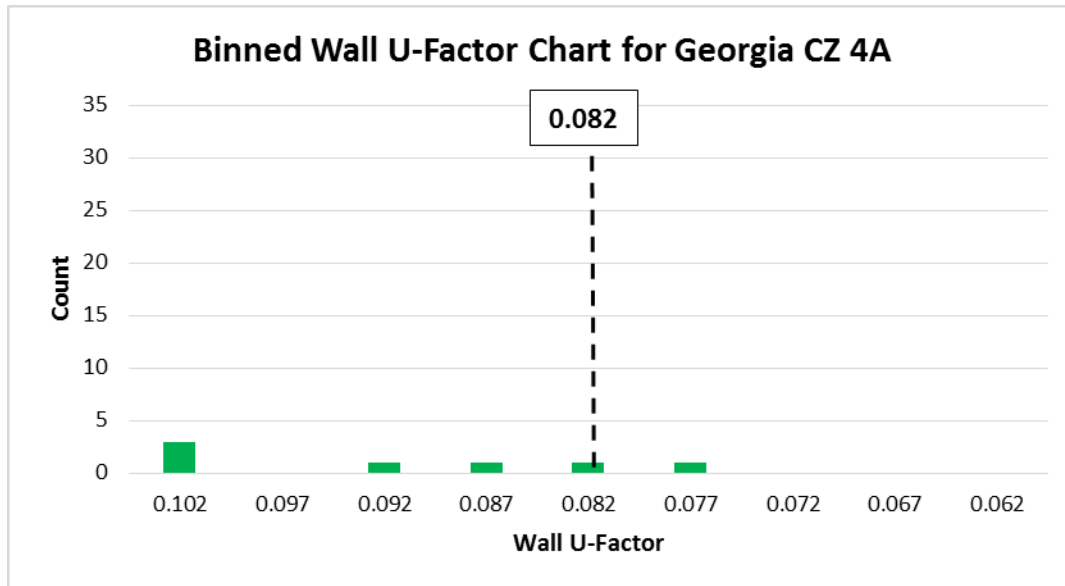

Figure 3.7. Wall Assembly Performance, including Insulation Installation Quality in CZ 4A

Figure 3.5, Figure 3.6, and Figure 3.7 combine all cavity R-value and wall insulation installation quality data observed in each climate zone to generate “effective U-factor” charts. The overall U-factor, as shown, is negatively affected due to the observed insulation installation quality. A more detailed discussion of insulation installation quality is included at the end of the section (3.1.1).

Table 3.4. Frame Wall Assembly

Climate Zone	CZ2	CZ3	CZ4	Statewide
<i>Number</i>	5	64	7	76
<i>Range</i>	0.102 to 0.083	0.102 to 0.062	0.102 to 0.077	0.102 to 0.062
<i>Average</i>	0.096	0.094	0.092	0.094
<i>Assembly U-Factor (expected)</i>	0.082	0.082	0.082	0.082
<i>Rate</i>	1 of 5 (20%)	10 of 64 (16%)	2 of 7 (29%)	13 of 76 (17%)

• **Interpretations:**

- Cavity insulation is achieved at a high rate—all the observations met or exceeded the prescriptive code requirement for wall cavity insulation (based on labeled R-value).
- From an assembly perspective, a majority of observations had below Grade I insulation installation quality—65 of 76 (86%) were rated as Grades II or III (Table 3.8).
- While cavity insulation appears to be achieved successfully (R-value), the overall assembly performance (U-factor) exhibits room for improvement—this can be a focal point for future education and training activities in the state.

3.1.1.5 Ceiling R-Value

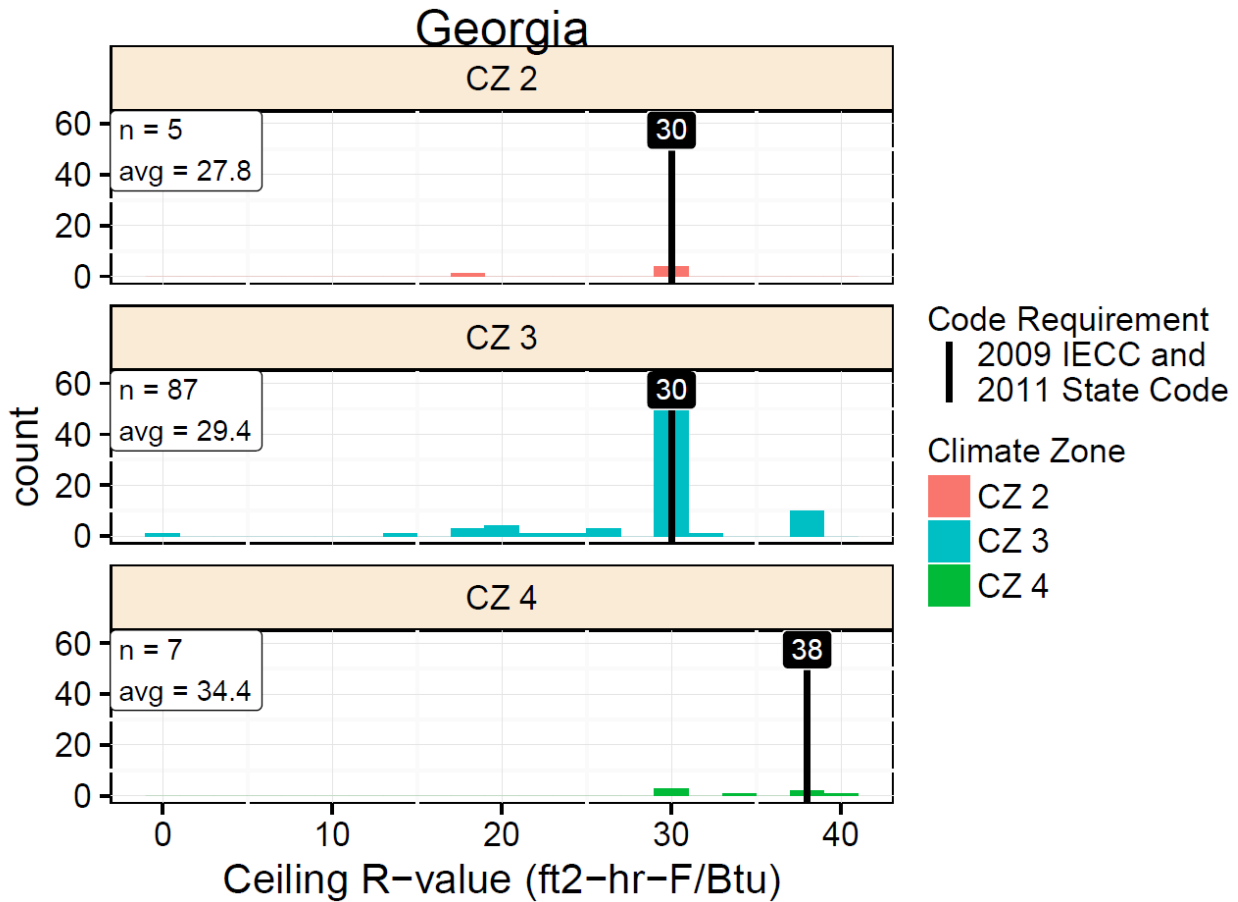

Figure 3.8. Ceiling R-Value

Table 3.5. Ceiling R-Value

Climate Zone	CZ2	CZ3	CZ4	Statewide
Number	5	87	7	99
Range	19 to 30	0 to 38	30 to 40	0 to 40
Average	27.8	29.4	34.4	4.3
Requirement	30	30	38	R-30 for CZ2 and CZ3, R-38 for CZ4
Compliance Rate	4 of 5 (80%)	73 of 87 (84%)	6 of 7 (86%)	83 of 99 (83%)

• **Interpretations:**

- There is a wide range of insulation values across the CZs, with the majority of ceilings at R-30 (69 of 99, 69%) and another significant fraction at R-38 (12 of 99, 12%).
- There is a lot of variation around R-30 and R-38 in the data. For example, there are two observations of R-27, one of R-33, and one of R-35, and a value of R-40.

The project team observed that the variation around R-30 and R-38 is due to the project team’s method for collecting information. Instead of recording what was on the insulation card in the attic (installed by

the insulation contractor), the project team measured insulation height in 3-4 locations around the attic and calculated R-value based on insulation type and height. The actual installed value occasionally varied from what was listed on the insulation card.

Additionally, the project team noted that the cause of some instances below R-30 may point to the use of a UA trade-off path. The project team recorded insulation locations for 11 of the 15 houses that had less than R-30. In those cases, 7 of the observations indicated insulation installed on the roof rafters, the typical location for spray foam insulation.

3.1.1.6 Lighting

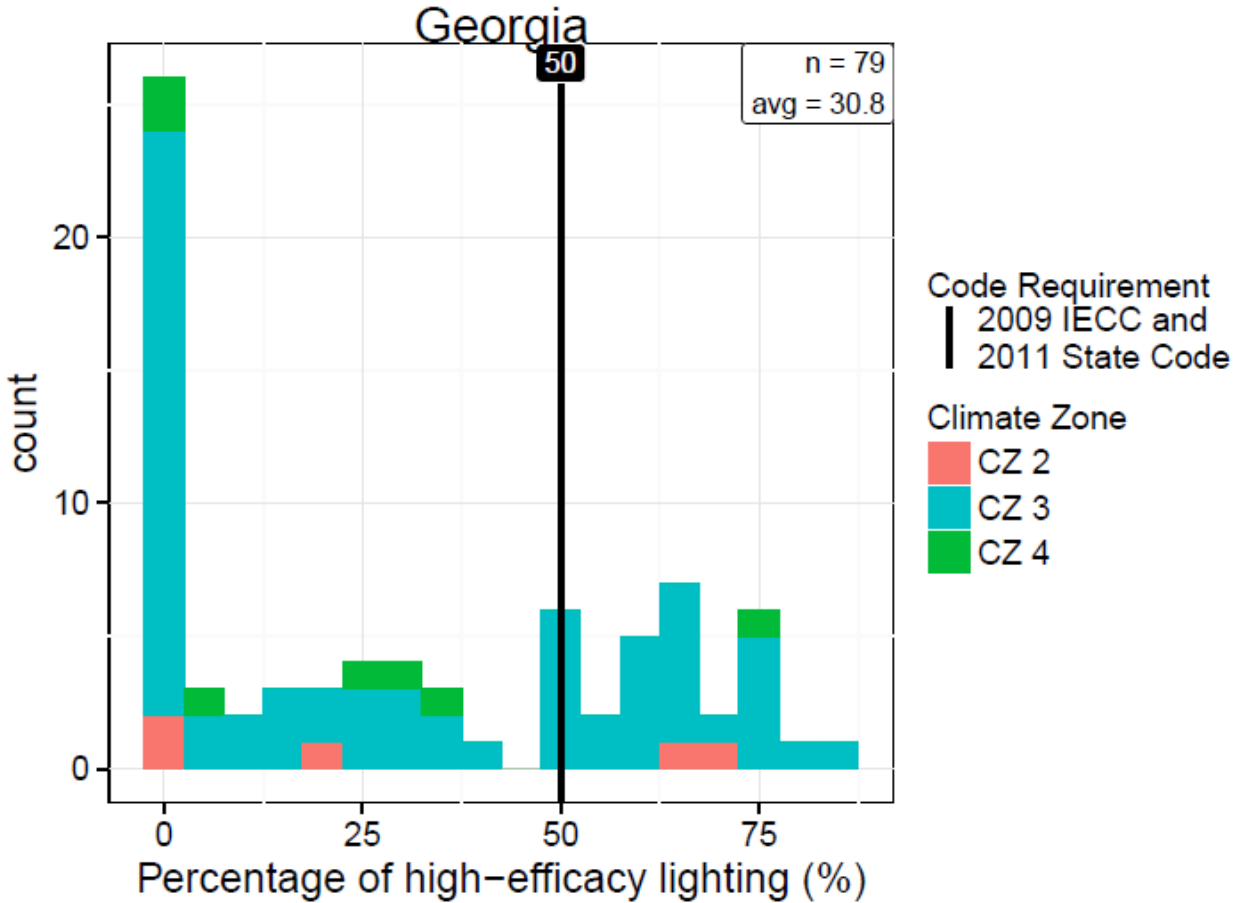

Figure 3.9. High-efficacy Lighting Percentage

Table 3.6. High-efficacy Lighting Percentage

Climate Zone	CZ2	CZ3	CZ4	Statewide
<i>Number</i>	5	67	7	79
<i>Range</i>	0 to 70	0 to 86	0 to 75	0 to 86
<i>Average</i>	31.2	31.4	24.4	30.8
<i>Requirement</i>	50	50	50	50
<i>Compliance Rate</i>	2 of 5 (40%)	26 of 67 (39%)	1 of 7 (14%)	29 of 79 (38%)

• **Interpretations:**

- There are a significant quantity and wide range of observations that do not meet the minimum code requirements.
- In CZ2 and CZ3, less than half of the observations meet the current code requirement, and that drops significantly in CZ4.
- This should be considered an area for increased attention in future training and enforcement.

3.1.1.7 Duct Tightness

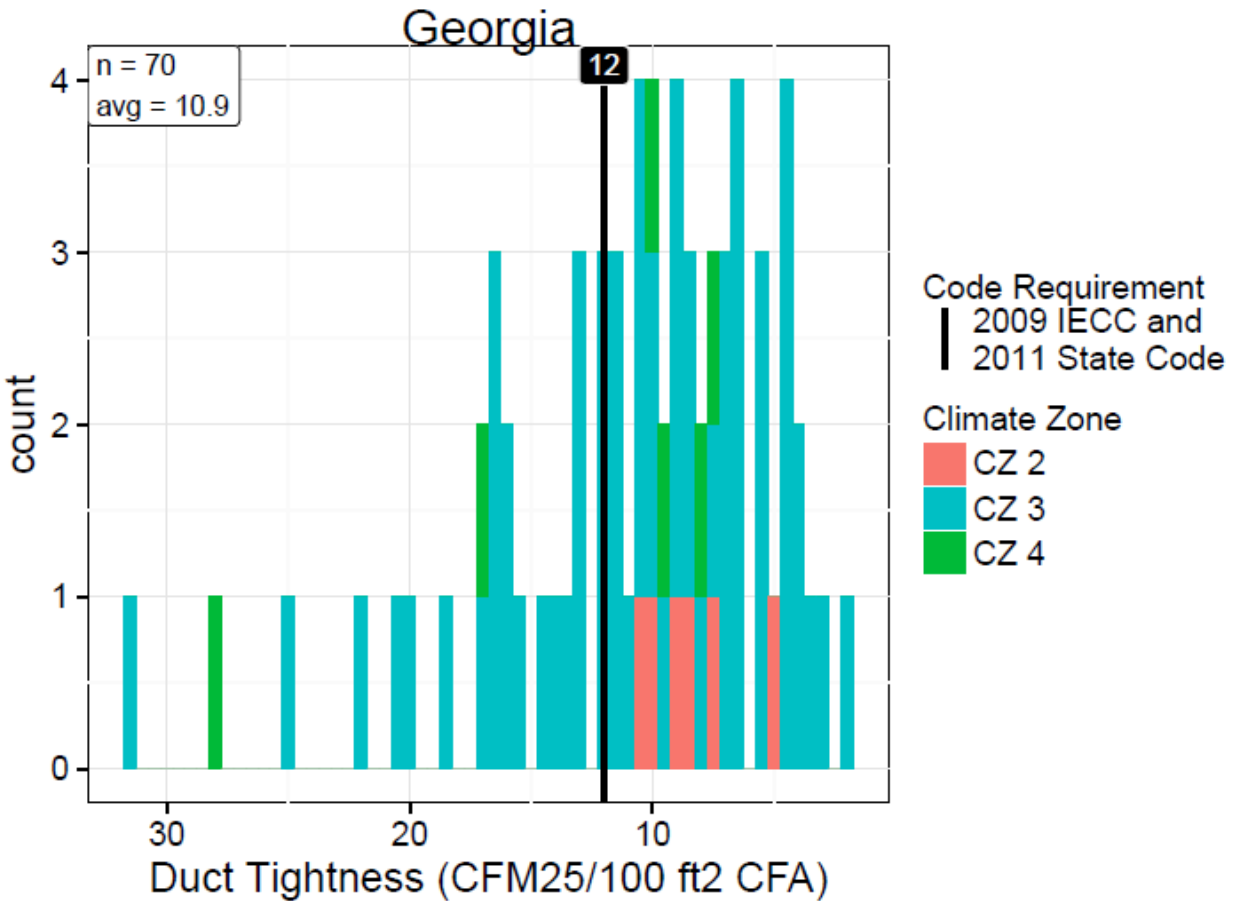

Figure 3.10. Duct Tightness (CFM25/100ft2 CFA)

Table 3.7. Duct Tightness

Climate Zone	CZ2	CZ3	CZ4	Statewide
<i>Number</i>	6	58	6	70
<i>Range</i>	5.0 to 10.7	3.0 to 31.5	7.3 to 28.0	3.0 to 31.5
<i>Average</i>	8.4	10.9	13.3	10.9
<i>Requirement</i>	12	12	12	12
<i>Compliance Rate</i>	6 of 6 (100%)	38 of 58 (66%)	4 of 6 (67%)	48 of 70 (69%)

- **Interpretations:**

- Overall, the distribution exhibits higher leakage than expected based on the code requirement.
- Reductions in duct leakage represent an area for improvement within the state, and should be given increased attention in future training and enforcement.

The project team noted that there were cases where the ducts did not meet total leakage, but, most likely, would have passed a leakage-to-outdoors test. The project team intends to focus on the duct sealing requirements to ensure that the construction industry recognizes that ducts must be sealed, regardless of the testing method.

3.1.1.8 Impact of Insulation Installation Quality

At the start of the project, insulation installation quality was noted as a particular concern among project teams and stakeholders, as it plays an important role in the energy performance of envelope assemblies. Insulation installation quality was therefore collected by the field teams whenever possible, and applied as a *modifier* in the analyses for applicable key items (i.e., ceiling insulation, wall insulation, and foundation insulation). Teams followed the RESNET¹⁷ assessment protocol which has three grades, Grade I being the best quality installation and Grade III being the worst.

Table 3.8 shows the insulation installation quality levels for framed envelope assemblies, as observed in the state. The majority of the observations (234 of 269) were classified as Grades II and III, indicating that there is significant room for improvement in insulation installation quality.

Table 3.8. Insulation Installation Quality

Assembly	Grade I	Grade II	Grade III	Total Observations
Roof Cavity	18	45	33	96
Above Grade Wall	11	28	37	76
Knee Wall	1	9	18	28

3.1.2 Additional Data Items

The project team collected data on all code requirements within the state as well as other areas to inform the energy simulation and analysis for the project (e.g., home size, installed equipment systems, etc.). While these items were not the focal point of the study, and many are not considered statistically representative, they do provide some insight surrounding the energy code and residential construction within the state.

The following represents a summary of this data and outlines some of the more significant findings, in many cases including the observation or compliance rate associated with the specified item. A larger selection of the additional data items collected as part of the Georgia field study is contained in Appendix C. The full data set is also available on the DOE Building Energy Codes Program website.¹⁸

¹⁷ See http://www.resnet.us/standards/RESNET_Mortgage_Industry_National_HERS_Standards.pdf

¹⁸ Available at <https://www.energycodes.gov/compliance/residential-energy-code-field-study>

3.1.2.1 Average Home

- Size: 2777 ft² and 2.15 stories

3.1.2.2 Compliance

- The majority of homes were permitted under the 2009 IECC GA (99.5%) or 2015 IECC (0.5%) (n=210)

3.1.2.3 Envelope

- **Profile:**
 - Walls (n=68): All were wood-framed walls with a mix of 4” (94%) and 6” (6%) studs
 - Foundations (n=157): Mix of basements (32%)¹⁹, slab-on-grade (62%) and crawlspaces (6%)
- **Areas for Improvement:**
 - Utility penetrations were not sealed (71%) (n=17)
 - Knee walls were not sealed (38%) (n=13)

3.1.2.4 Duct & Piping Systems

- **Profile:**
 - Ducts were rarely located within conditioned space (percentage of duct system):
 - Supply: 30% (1 home entirely within conditioned space) (n=28)
 - Return: 26% (1 home entirely within conditioned space) (n=27)
 - About 3% of homes located *supply* ducts entirely within conditioned space
 - About 3% of homes located *return* ducts entirely within conditioned space

3.1.2.5 HVAC Equipment

- **Profile:**
 - Heating (n=35): Mix of gas furnaces (71%) with an average efficiency of 0.82 AFUE and heat pumps (29%) with an average efficiency of 8.3 HSPF. All furnaces observed in the study had an efficiency of 0.80 AFUE or better.
 - Cooling (n=29): Mix of central A/C (69%) and heat pump (31%) with an average efficiency of 13.8 SEER
 - Water Heating (n=29): Mix of gas (59%) and electric (41%) storage with an average capacity of 57 gallons and average efficiency rating of EF 0.75

3.2 Energy Intensity

The statewide energy analysis results are shown in the figures below, which compare the weighted average energy consumption of the observed data set to the weighted average consumption based on the

¹⁹ 38% of the basement observations in the study were conditioned

state energy code. The observed data set (as gathered in the field) was compared against the same set of homes meeting prescriptive code requirements. In terms of overall energy consumption, homes in Georgia appear to use *less* energy than would be expected relative to homes built to the current minimum state code requirements.

Analysis of the collected field data indicates an average regulated EUI (dashed line in Figure 3.11) of 26.52 kBtu/ft²-yr compared to 28.52 kBtu/ft²-yr for homes exactly meeting minimum *prescriptive* energy code requirements (black line in Figure 3.11). This suggests the EUI for a “typical” home in the state is about 6% better than code.

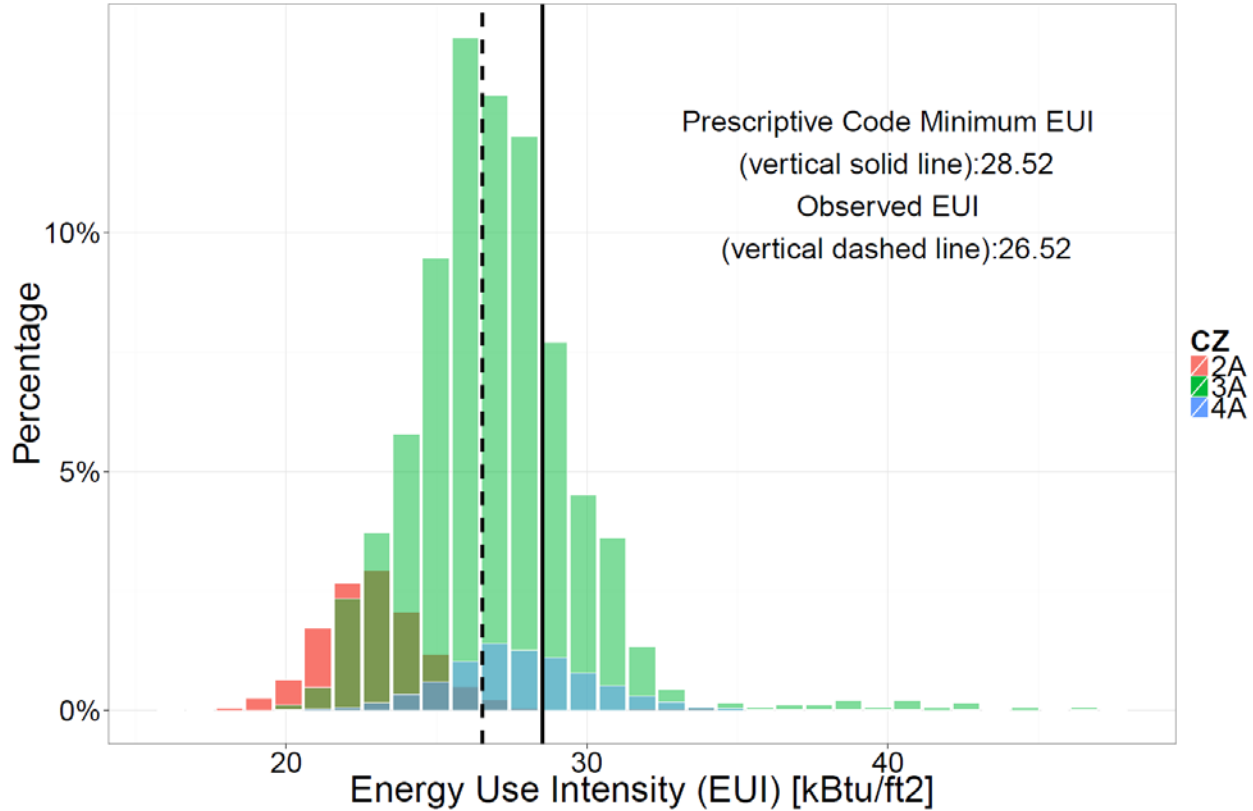

Figure 3.11. Statewide EUI Analysis for Georgia (GA State Code)

When the observed EUI of 26.52 kBtu/ft²-yr is compared to 28.61 kBtu/ft²-yr for homes meeting the 2009 IECC (Figure 3.12), the EUI for the typical home in the state is about 7% better than code.

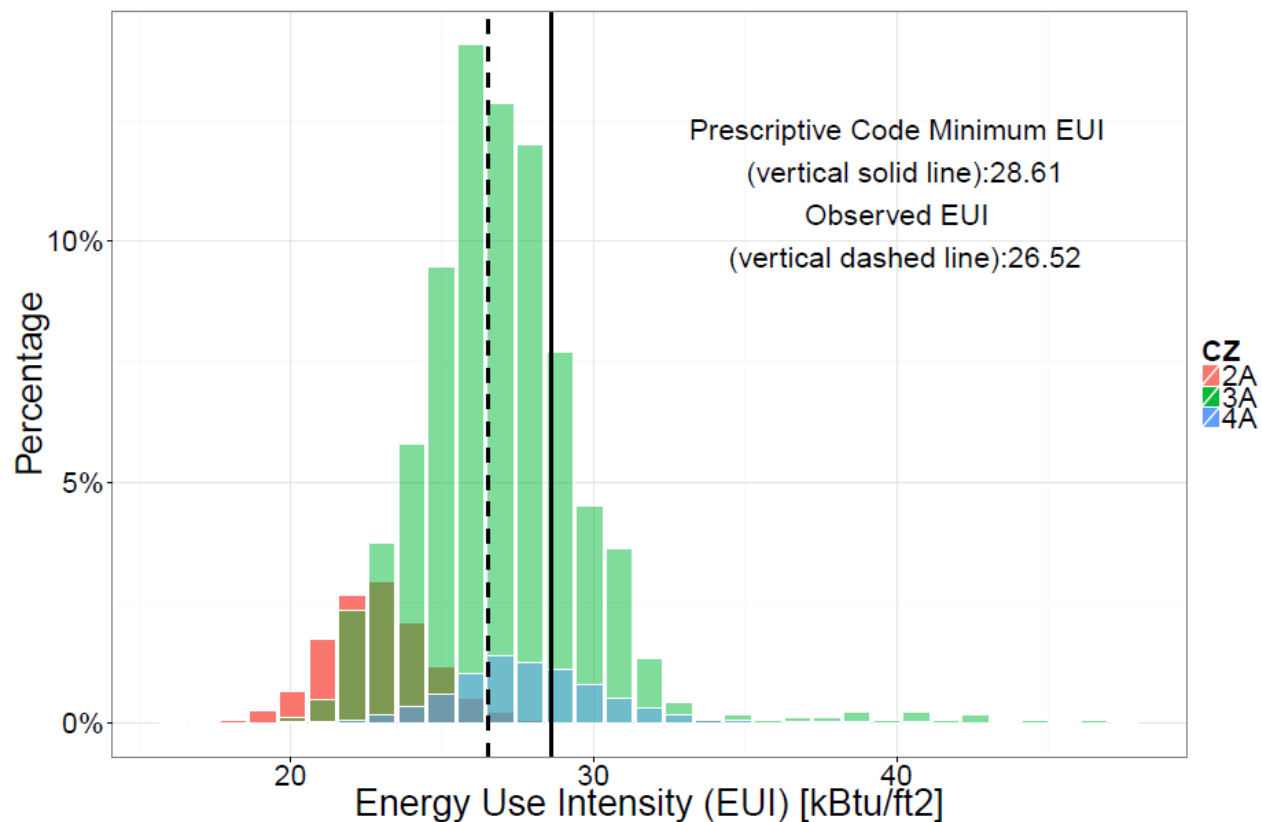

Figure 3.12. Statewide EUI Analysis for Georgia (2009 IECC)

3.3 Savings Potential

All data in this study was collected from homes permitted under the Georgia Energy Code and therefore all potential savings were calculated against that code. Several key items exhibit the potential for improvement. Those key items with the greatest potential²⁰, shown below followed by the percent of observations that met or exceeded the associated code requirement, were analyzed further to calculate the associated savings potential, including energy, cost and carbon savings.

- Exterior Wall Insulation (99%),
- Ceiling Insulation (81%),
- Duct Leakage (69%), and
- Lighting (37%).

For analytical details refer to Section 2.3.3 (Savings Analysis) or the methodology report (DOE 2016).

Estimated savings resulting from the analysis are shown below in order of highest to lowest total energy, cost and carbon savings (Table 3.9). As can be seen, there are significant savings opportunities, with the

²⁰ Defined here as those with less than 85% of observations meeting the prescriptive code requirement. Some insulation measures were also included when a significant number of observations had insulation installation quality of Grades II or III.

greatest total energy savings potential associated with these measures. In addition, Table 3.10 shows the total savings and emissions reductions that will accumulate over 5, 10, and 30 years of construction.

Table 3.9. Statewide Annual Measure-Level Savings for Georgia (GA Energy Code)

Measure	Climate Zone	Electricity Savings (kWh/home)	Natural Gas Savings (therms/home)	Total Savings (kBtu/home)	Number of homes	Total Energy Savings (MMBtu)	Total Energy Cost Savings (\$)	Total State Emissions Reduction (MT CO ₂ e)
Exterior Wall Insulation	2A	172	8	1,378	3,410	4,700	123,872	548
	3A	182	11	1,746	21,920	38,283	930,211	4,054
	4A	186	12	1,880	2,173	4,086	97,183	422
	State Total	181	11	1,711	27,503	47,069	1,151,262	5,023
Lighting	2A	222	-1	631	3,410	2,153	104,221	498
	3A	213	-2	565	21,920	12,393	632,177	3,037
	4A	213	-2	565	2,173	1,228	62,666	301
	State Total	214	-2	574	27,503	15,774	799,065	3,837
Duct Leakage	2A	113	3	730	3,410	2,490	72,832	320
	3A	122	5	944	21,920	20,699	553,200	2,425
	4A	135	5	1,011	2,173	2,198	59,653	260
	State Total	122	5	923	27,503	25,387	685,683	3,005
Ceiling Insulation	2A	55	2	406	3,410	1,383	37,912	169
	3A	56	3	477	21,920	10,464	268,651	1,183
	4A	134	7	1,173	2,173	2,550	64,552	284
	State Total	62	3	523	27,503	14,397	371,110	1,635
TOTAL		579	17	3,731	27,503	102,627	3,007,120	13,500

Table 3.10. Five-years, Ten-years, and Thirty-years Cumulative Annual Statewide Savings for Georgia (GA Energy Code)

Measure	Total Energy Savings (MMBtu)			Total Energy Cost Savings (\$)			Total State Emissions Reduction (MT CO2e)		
	5yr	10yr	30yr	5yr	10yr	30yr	5yr	10yr	30yr
Exterior Wall Insulation	706,035	2,588,795	21,887,085	17,268,930	63,319,410	535,336,830	75,345	276,265	2,335,695
Lighting	236,610	867,570	7,334,910	11,985,975	43,948,575	371,565,225	57,555	211,035	1,784,205
Duct Leakage	380,805	1,396,285	11,804,955	10,285,245	37,712,565	318,842,595	45,075	165,275	1,397,325
Ceiling Insulation	215,955	791,835	6,694,605	5,566,650	20,411,050	172,566,150	24,525	89,925	760,275
TOTAL	1,539,405	5,644,485	47,721,555	45,106,800	165,391,600	1,398,310,800	202,500	742,500	6,277,500

4.0 Conclusions

The Georgia field study provides an enhanced understanding of statewide code implementation, and suggests that significant savings are available through increased compliance with the Georgia energy code. From a statewide perspective, the average home in Georgia uses about 6% less energy than a home exactly meeting the state energy code. However, significant savings potential remains through increased compliance with targeted measures. Potential statewide annual energy savings are 102,627 MMBtu, which equates to \$3,007,120 in cost savings, and emission reductions of 13,500 MT CO₂e. Over a 30-year period, these impacts grow to 47.7 million MMBtu, \$1.4 billion, and over 6.2 million MT CO₂e in avoided emissions.

Several key measures directly contribute to these savings, and should be targeted through future education, training and outreach activities. The savings associated with each are:

Table 4.1. Annual Statewide Savings Potential in Georgia

Key Measure		Annual Savings		
		Energy (MMBtu)	Cost (\$)	Carbon (MT CO₂e)
1	Exterior Wall Insulation	47,069	1,151,262	5,023
2	Lighting	15,774	799,065	3,837
3	Duct Leakage	25,387	685,683	3,005
4	Ceiling Insulation	14,397	371,110	1,635
Total		102,627 MMBtu	\$3,007,120	13,500 MT CO₂e

5.0 References

Census Bureau. 2016. Censtats Building Permits Database. <http://censtats.census.gov/>

DOE. 2012. *National Energy and Cost Savings for New Single- and Multifamily Homes: A Comparison of the 2006, 2009, and 2012 Editions of the IECC*, available at <http://www.energycodes.gov/development>

DOE Building Energy Codes Program’s residential field study website is available at <https://www.energycodes.gov/compliance/residential-energy-code-field-study> (accessed August 1, 2016).

DOE/PNNL 2016. “Residential Energy Code Field Study: Data Collection and Analysis.” Available at <https://www.energycodes.gov/compliance/residential-energy-code-field-study>

EnergyPlus. <https://energyplus.net/>.

The Georgia residential field study website is available at <http://seealliance.org/initiatives/built-environment/energy-codes/residential-energy-code-compliance-se/> (accessed August 10, 2016).

Residential Energy Services Network. 2013. “Mortgage Industry National Home Energy Rating System Standards.” Residential Energy Services Network, Oceanside, CA. www.resnet.us.

Appendix A

Stakeholder Participation

Appendix A

Stakeholder Participation

Table A.1. Stakeholder Participation in Project Kickoff Meeting

Stakeholder	Description
Home Builders Association of Georgia (HBAG)	The Home Builders Association of Georgia (HBAG) is part of a three-tiered federation of organizations who share a common mission: to serve the housing industry and provide expanding opportunities for all consumers to have safe, decent and affordable housing. Individual members join local associations, which in turn are affiliated with the Home Builders Association of Georgia and the National Association of Home Builders.
Georgia Power Company	The only investor-owned utility in Georgia and has the most customers of utilities in the state.
Georgia Public Service Commission	Agency responsible for approval of all utility energy efficiency programs.
Georgia Environmental Finance Agency	The Georgia State Energy Office resides at GEFA and is directly involved in the energy code adoption process.
Georgia Department of Community Affairs	The state entity in charge of all building codes.
Building Official Association of Georgia (BOAG)	The organization that represents all code officials in the state of Georgia.
Conditioned Air Association of Georgia (CAAG)	The Conditioned Air Association of Georgia (CAAG) is a state-wide, non-profit trade association which represents heating, ventilation, air conditioning and refrigeration contractors (HVACR) who work on residential, commercial and industrial construction projects.
Georgia Building Performance Association	Georgia Building Performance Association (GABPA) was formed in June of 2015 to offer Georgia's home and building performance companies and professionals support and representation in the marketplace.
American Institute of Architects, Georgia Chapter (AIA-GA)	A professional organization for architects that offers education, government advocacy, community redevelopment, and public outreach to support the architecture profession.

Appendix B
State Sampling Plan

Appendix B

State Sampling Plan

B.1 State Sampling Plan

Table B.1. State Sampling Plan

Location	Sample	Actual
Forsyth County Unincorporated Area, Forsyth	8	8
Gwinnett County Unincorporated Area, Gwinnett	5	4 – Gwinnett County 1 – Dekalb County
Columbia County Unincorporated Area, Columbia	2	2
Cobb County Unincorporated Area, Cobb	4	4
Cherokee County Unincorporated Area, Cherokee	2	2
Atlanta, Fulton	2	2
Lowndes County Combined, Lowndes	1	1
Henry County Unincorporated Area, Henry	2	1 – Henry County 1 – Douglasville
Milton, Fulton	2	2
Oconee County Unincorporated Area, Oconee	2	2
Warner Robins, Houston	2	2
Paulding County Unincorporated Area, Paulding	1	1
Coweta County Unincorporated Area, Coweta	1	1
Woodstock, Cherokee	1	1
Sandy Springs, Fulton	2	2
Smyrna, Cobb	2	2
Houston County Unincorporated Area, Houston	1	1
Effingham County Unincorporated Area, Effingham	1	1
Hinesville, Liberty	1	1
Fannin County, Fannin	1	1
Fayette County Unincorporated Area, Fayette	1	1
Perry, Houston	1	1
Harris County Unincorporated Area, Harris	1	1
Canton, Cherokee	1	1
Spalding County Unincorporated Area, Spalding	1	1
Marietta, Cobb	2	2
Greene County, Greene	1	1 – Oconee County
Catoosa County Unincorporated Area, Catoosa	1	1
Richmond Hill, Bryan	1	1
Braselton town, Jackson	1	1

Location	Sample	Actual
Thomas County Unincorporated Area, Thomas	1	1
Jackson County Unincorporated Area, Jackson	1	1
Dawson County Unincorporated Area, Dawson	2	2
Rockdale County Unincorporated Area, Rockdale	1	1
Carrollton, Carroll	1	1 – Unincorporated Carroll County
Habersham County Unincorporated Area, Habersham	1	1
Baldwin County Unincorporated Area, Baldwin	1	1
Peach County Unincorporated Area, Peach	1	1
Total	63	63

B.2 Substitutions

In the Georgia study, the project team had to substitute 4 samples in total from one jurisdiction to another. The substitute counties were selected to best match the social demographics of the original county. Each substitution was considered individually, with additional details for each provided below:

- **Original: City of Carrollton. Substitution: City of Carrollton and Unincorporated Carroll County.** In the original sample plan, the project team was to collect one sample set from the City of Carrollton in Carroll County. However, upon receiving the permit list from the Carrollton Building Department, the project team discovered that the number of new single-family permits (3) was far below the previous years, and well below a level that was considered adequate for the study. Unincorporated Carroll County was identified as an acceptable alternative and did have sufficient permits. Although these jurisdictions have different building departments, it was assumed that the construction community serves both jurisdictions and samples from both would provide an accurate portrait of the location. Therefore, the project team combined the City of Carrollton and unincorporated Carroll County to complete the one required sample set.
- **Original: Greene County. Substitution: Oconee County.** Greene County required one sample set based on the original sampling plan. Permits were obtained and site visits were conducted, but the project team was unable to complete the sample due to limited access to houses. Oconee County was selected as a substitution due to its adjacent location, similar construction type (e.g., many lakefront homes in gated communities), and similar median sale prices compared to Greene County.
- **Original: Henry County. Substitution: City of Douglasville.** The original sampling plan required two samples from Henry County. One complete sample set was achieved; however, the project team exhausted all available permits before fulfilling the second sample set. Douglasville was determined to be an appropriate sample due to its similar proximity to the metro Atlanta region and similar median house price.
- **Original: Gwinnett County Unincorporated. Substitution: Dekalb County Unincorporated.** The original sampling plan required five samples from Gwinnett County. Four complete sample sets were achieved; however, the project team exhausted all available permits before fulfilling the last sample set. Dekalb County was determined to be an appropriate sample due to its similar proximity to the metro Atlanta region and similar median house price.

Appendix C

Additional Data

Appendix C

Additional Data

C.1 Additional Data Collected by Field Teams

The project team made observations on several energy efficiency measures beyond the key items alone. The majority of these additional items are based on code requirements within the state, while others were collected to inform the energy simulation and analysis for the project (e.g., installed equipment, whether the home participated in an above-code program, etc.). While these items were not the focal point of the study, and many are not considered statistically representative, they do provide some additional insight surrounding the energy code and residential construction within the state.

The following is a sampling of the additional data items collected as part of the Georgia field study. Each item is presented, along with a brief description and statistical summary based on the associated field observations. The full data set is available on the DOE Building Energy Codes Program website.¹

C.1.1 General

The following represents the general characteristics of the homes observed in the study.

C.1.1.1 Average Home

- Size (n=45): 2777 ft²
- Number of Stories (n=95): 2.15

Table C.1. Conditioned Floor Area (ft²)

Conditioned Floor Area (ft ²)	< 1000	1000 to 1999	2000 to 2999	3000 to 3999	4000+
Percentage	0%	9%	52%	33%	6%

Table C.2. Number of Stories

No. of Stories	1	1.5	2	3	4+
Percentage	7%	1%	68%	23%	0%

C.1.1.2 Wall Profile

- Framing Type (n=68):
 - All were framed construction (100%)
- Framing Material (n=75):

¹ Available at <https://www.energycodes.gov/compliance/residential-energy-code-field-study>

- Wood (100%)
- Steel (0%)
- Framing Depth (n=63):
 - 4” (94%)
 - 6” (6%)

C.1.1.3 Foundation Profile

- Foundation Type (n=157):
 - Basement (32%)
 - Slab on Grade (62%)
 - Crawlspace (6%)
- Basement Type (n=52):
 - Conditioned (38%)
 - Unconditioned (62%)

C.1.1.4 Other

- *None* had a pool or spa (n=5)
- *None* had a sunroom (n=14)

C.1.2 Compliance

The following summarizes information related to compliance, including the energy code associated with individual homes, whether the home was participating in an above-code program, and which particular programs were reported. The percentages provided in the sections below represent percentages of total observations or the percentage of observations that complied.

C.1.2.1 Energy Code Used (n= 210):

Table C.3. Energy Code Used

Energy Code	2009 IECC GA	2015 IECC
Percentage	99.5%	0.5%

C.1.3 Envelope

The following list of questions focus on average characteristics of the thermal envelope:

C.1.3.1 Insulation Labels

- Was insulation labeled (n=5)?

- Yes (100%)
- No (0%)

C.1.3.2 Ceilings

- Did the attic hatch/door exhibit the correct insulation value (n=36)?
 - Yes (81%)
 - No (19%)

C.1.3.3 Air Sealing¹

The following indicate whether sealing was completed in accordance with the checklist and associated code requirements.

- Thermal envelope sealed (n=12) (42%)
- Fenestration sealed (n=13) (69%)
- Openings around windows and doors sealed (n=11) (73%)
- Utility penetrations sealed (n=17) (71%)
- Knee walls sealed (n=13) (38%)
- Garage walls and ceilings sealed (n=10) (30%)
- Envelope behind tubs and showers sealed (n=6) (100%)
- Attic access openings sealed (n=8) (63%)
- Rim joists sealed (n=6) (67%)
- Other sources of infiltration sealed (n=6) (33%)

C.1.4 Duct & Piping Systems

The following represents an average profile of observed air ducting and water piping systems, followed by a list of additional questions related to such systems:

C.1.4.1 System Profile

- Duct Location in Conditioned Space (percentage):
 - *Supply* (n=28): 30% (1 home with systems located entirely within conditioned space)
 - *Return* (n=27): 26% (1 home with systems located entirely within conditioned space)
- Duct Insulation in Unconditioned Space (R-value):
 - *Supply* (n=3): 8
 - *Return* (n=4): 8

¹ Note that results in this section are from checklist items that are addressed via visual inspection. When comparing these visual results with the actual tested results, it is clear that there can be significant differences in the two methods.

- Ducts in Attics (R-value):
 - Supply (n=8): 8
 - Return (n=8): 7.3
- Pipe Insulation (R-value):
 - Two responses had a value of a value of R-2 and one was zero (n=3)
- Air handlers sealed (n=5) (60%)
- Filter boxes sealed (n=5) (20%)

C.1.5 HVAC Equipment

The following represents an average profile of observed HVAC equipment, followed by:

C.1.5.1 Heating

- Fuel Source (n=35):
 - Gas (71%)
 - Electricity (29%)
- System Type (n=35):
 - Furnace (71%)
 - Heat Pump (29%)
- System Capacity (n=14):
 - Furnace: 76,900 Btu/hr
 - Heat Pump: 76,500 Btu/hr¹
- System Efficiency (n=20):
 - Furnace: 0.82 AFUE (*all* observed furnaces had an efficiency of 0.80 AFUE or better)
 - Heat Pump: 8.3 HSPF

C.1.5.2 Cooling

- System Type (n=29):
 - Central AC (69%)
 - Heat Pump (31%)
- System Capacity (n=17):
 - 40,600 (Btu/hr)
- System Efficiency (n=20):

¹ This value is greatly influenced by one very large heat pump system. Heating capacity listed as 366,600 Btu/hr. However, the same home has a cooling system capacity for the heat pump listed as 34,600 Btu/hr, indicating that this could be a typographical error in the data.

- 13.8 SEER (observations ranged from 13 to 14.5 SEER)

C.1.5.3 Water Heating

- Fuel Source (n=29):
 - Gas (59%)
 - Electric (41%)
- System Type (n=30):
 - Tank (93%)
 - Tankless (7%)
- System Capacity (n=23):
 - 56.6 gallons (observations ranged from 50 to 80 gallons)

Table C.4. Water Heating System Storage Capacity Distribution

Capacity	< 50 gal	50-59 gal	60-69 gal	70-79 gal	80-89 gal	90+ gal
Percentage	0%	78%	0%	0%	22%	0%

- System Efficiency (n=22):
 - EF 0.75

C.1.5.4 Ventilation

- System Type (n=1):
 - AHU-Integrated (10 %)

C.1.5.5 Other

- Programmable thermostat installed (n=11) (82%)



Pacific Northwest
NATIONAL LABORATORY

*Proudly Operated by **Battelle** Since 1965*

902 Battelle Boulevard
P.O. Box 999
Richland, WA 99352
1-888-375-PNNL (7665)

U.S. DEPARTMENT OF
ENERGY

www.pnnl.gov